

SECTION C

Table of Contents



Watertight Devices



FD Boxes and Angled Adapters



GFCI Protected FD Box



Product	Page
Watertight Safety-Shroud® Twist-Lock® Devices	
20A and 30A Devices	C-3
Accessories	C-4
Watertight Devices	
15A and 20A, Straight Blade Devices	C-6
15A, 20A and 30A, Twist-Lock® Devices	C-7
Accessories	C-8

Product	Page
FD Boxes and Angled Adapters	C-9
GFCI Protected FD Box	C-10
Portable Outlet Boxes and Covers	C-11
Heavy Duty Portable Outlet Boxes and Plates	C-12
Dimensions	C-13
Technical Information	C-14

Watertight Devices

Features and Benefits

Watertight Safety-Shroud® Twist-Lock® System

- Virtually eliminates bent and broken plug blades, leading to longer equipment life
- Extends life of mating receptacles by eliminating damage caused by insertion of bent blades
- Extra protection for personnel by significantly reducing chance of inadvertent contact with blades when connecting or disconnecting energized receptacles and connector bodies
- Reduces exposure to arcing when connecting or disconnecting plugs under load
- Compliance with California Code of Regulations, Title 8, Article 51, subsection 2510.7(b), which requires shrouding for devices exceeding 300 volts
- Lockout/tagout hole allows compliance with OSHA regulation 29 CFR 1910.147

Note: Works with Mechanical Interlocks, see page B-41 for additional information.



HBL2731SW



HBL2733SW



Housing Design

- One-piece, engineered thermoplastic housing is impact-resistant for heavy duty industrial environments
- Blades are recessed for protection against bending and breaking
- Closure cap is included for environmental seal when device is not in use



Assembly

- Cord grip screw recess minimizes screwdriver slippage
- All screws are #10 multiple drive head



Cord Range

- Assorted TPE seal glands can accommodate a wide range of cord sizes from #16-3 Type SJ to #8-5 Type S, SO
- Sealing gland and thermoplastic guard prevents water ingress from entering the device at the cord end



Panel or Box Mount Receptacles and Inlets

- High impact, thermoplastic housing for heavy duty industrial environments
- Mounting screw recesses minimize screwdriver slippage
- Accepts all mating NEMA locking plugs and most connector bodies, allowing interchangeability with existing devices



Identification

- Catalog number and color-coded voltage rating are easily visible even when in use
- Alignment arrows and lock and unlock symbols provide a visual indication that devices are properly connected



Spring-Loaded Cover

- One-step, push-to-close, spring-loaded cover with latch allows for fast opening and closing of lift cover
- Result: Environmental sealing is assured

Watertight Safety-Shroud® Twist-Lock® Devices



	NEMA Rating Color Coded by Voltage	Plug/ Connector	Poles/Wires	Plug	Connector	Flanged Inlet	Receptacle
20 Amp	NEMA L5-20 20A 125V		2P/3W	HBL2311SW	HBL2313SW	HBL2315SW	HBL2310SW
	NEMA L6-20 20A 250V		2P/3W	HBL2321SW	HBL2323SW	HBL2325SW	HBL2320SW
	NEMA L7-20 20A 277V AC		2P/3W	HBL2331SW	HBL2333SW	HBL2335SW	HBL2330SW
	NEMA L14-20 20A 125/250V AC		3P/4W	HBL2411SW	HBL2413SW	HBL2415SW	HBL2410SW
	NEMA L15-20 20A 3Ø 250V AC		3P/4W	HBL2421SW	HBL2423SW	HBL2425SW	HBL2420SW
	NEMA L16-20 20A 3Ø 480V AC		3P/4W	HBL2431SW	HBL2433SW	HBL2435SW	HBL2430SW
	NEMA L21-20 20A 3ØY 120/208V AC		4P/5W	HBL2511SW	HBL2513SW	HBL2515SW	HBL2510SW
30 Amp	NEMA L5-30 30A 125V		2P/3W	HBL2611SW	HBL2613SW	HBL2615SW	HBL2610SW
	NEMA L6-30 30A 250V		2P/3W	HBL2621SW	HBL2623SW	HBL2625SW	HBL2620SW
	NEMA L14-30 30A 125/250V AC		3P/4W	HBL2711SW	HBL2713SW	HBL2715SW	HBL2710SW
	NEMA L15-30 30A 3Ø 250V AC		3P/4W	HBL2721SW	HBL2723SW	HBL2725SW	HBL2720SW
	NEMA L16-30 30A 3Ø 480V AC		3P/4W	HBL2731SW	HBL2733SW	HBL2735SW	HBL2730SW
	NEMA L17-30 30A 3Ø 600V AC		3P/4W	HBL2741SW	HBL2743SW	HBL2745SW	HBL2740SW
	NEMA L21-30 30A 3ØY 120/208V AC		4P/5W	HBL2811SW	HBL2813SW	HBL2815SW	HBL2810SW

Mechanical Interlock Switched Safety Enclosure

Description	Catalog Number
Unfused mechanical interlock integrates a watertight safety shroud receptacle with a linked disconnect switch. See page B-41 for additional information.	HBLMITL



HBLMITL

Specifications

Listings	
Listed to UL Standard 498 Certified to CSA Standard No.42 Fed. Spec. WC-596	
Environmental	
Moisture Resistance	UL Type 4, 4X, 12, IP66 suitability
Flammability (Enclosure)	V0 per UL94 or CSA 22.2 No. 0.17
Operating Temperatures	Maximum Continuous 75°C; Minimum -40°C (without impact)

Watertight Devices

Accessories

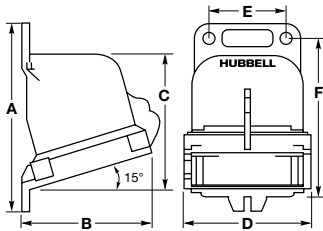

Non-Metallic Angle Box

15° Angle Non-Metallic Back Box

Description	NPT Hub Size	A Inch (mm)	B Inch (mm)	C Inch (mm)	D Inch (mm)	E Inch (mm)	F Inch (mm)	Cubic Inch Capacity	Catalog Number
For 20A and 30A Watertight Safety-Shroud Twist-Lock Receptacles and Inlets.	1"	5.67" (144.0)	4.44" (112.8)	4.05" (102.9)	3.91" (99.3)	2.35" (59.7)	4.92" (125.0)	30.00"	BB2030N

Note: Hub is not included; order Racco part number 1704. This box meets IP67 requirement and Type 4X requirements when installed with a watertight conduit hub.

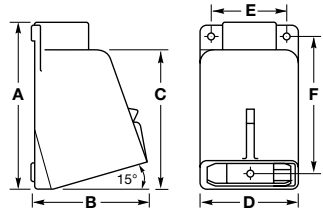

Metallic Angle Box

15° Angle Metallic Back Boxes

Description	NPT Hub Size	A Inch (mm)	B Inch (mm)	C Inch (mm)	D Inch (mm)	E Inch (mm)	F Inch (mm)	Cubic Inch Capacity	Catalog Number
For 20A and 30A Watertight Safety-Shroud Twist-Lock Receptacles and Inlets.	¾"	5.13" (130.2)	4.00" (101.6)	4.19" (106.4)	3.75" (95.3)	3.00" (76.2)	4.00" (101.6)	30.00"	BB201W
	1"	5.13" (130.2)	4.00" (101.6)	4.19" (106.4)	3.75" (95.3)	3.00" (76.2)	4.00" (101.6)	30.00"	BB301W

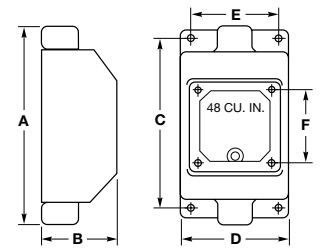

Metallic Feed Thru Box

Metallic Feed Thru Back Boxes

Description	NPT Hub Size	A Inch (mm)	B Inch (mm)	C Inch (mm)	D Inch (mm)	E Inch (mm)	F Inch (mm)	Cubic Inch Capacity	Catalog Number
For 20A and 30A Watertight Safety-Shroud Twist-Lock Receptacles and Inlets.	¾"	8.25" (209.6)	3.06" (77.8)	7.14" (181.4)	4.50" (114.3)	3.75" (95.3)	3.13" (79.5)	48.00"	FT202W
	1"	8.25" (209.6)	3.06" (77.8)	7.14" (181.4)	4.50" (114.3)	3.75" (95.3)	3.13" (79.5)	48.00"	FT302W

Note: These boxes are cast aluminum and are finished with enamel paint. These boxes withstand a 500-hour salt spray test as well as UL raintight and external icing tests. NPT (metric designator).

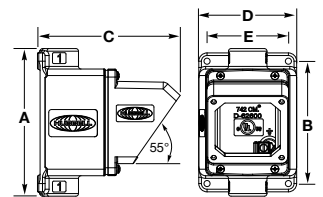

AB203055

55° Angle Metallic Adapter and Back Box

Description	NPT Hub Size	A Inch (mm)	B Inch (mm)	C Inch (mm)	D Inch (mm)	E Inch (mm)	F Inch (mm)	Cubic Inch Capacity	Catalog Number
For 20A and 30A Watertight Safety-Shroud Twist-Lock Receptacles and Inlets.	1"	6.80" (172.4)	5.63" (142.9)	6.60" (167.0)	4.50" (114.3)	3.74" (95.0)	-	45.27"	AB203055

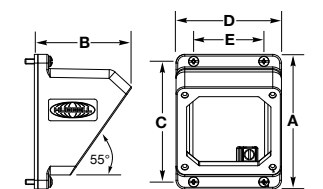

AA203055

55° Angle Metallic Adapter with Grounding Lug

Description	A Inch (mm)	B Inch (mm)	C Inch (mm)	D Inch (mm)	E Inch (mm)	F Inch (mm)	Cubic Inch Capacity	Catalog Number
For 20A and 30A Watertight Safety-Shroud Twist-Lock Receptacles and Inlets.	4.89" (124.2)	3.33" (84.8)	4.29" (109.1)	3.75" (95.3)	2.50" (63.5)	-	25.00"	AA203055



HBL2030AP

Straight Watertight Wall Box Adapter

Description	Catalog Number
Adapts 20A and 30A Watertight Safety-Shroud Twist-Lock receptacles and inlets to 2-gang, device mount, FD boxes.	HBL2030AP



AA2030PS

Non-Watertight Angle Wall Box Adapter

Description	Catalog Number
Adapts 20A and 30A Watertight Safety-Shroud Twist-Lock receptacles to 1- or 2-gang standard wall boxes (4" or 4 1/16" square).	AA2030PS

Dimensions in Inches (mm)

Watertight Devices

Features and Benefits

Watertight Devices

- The triple bypass seal provides a Watertight UL Type 4X seal where devices are mated
- The cone seal at the cable entrance provides protection from water ingress
- Strongest strain relief for any Watertight device on the market, utilizing the patented Gotcha ring and collapsible bushing combination
- Nickel plated brass contacts and stainless steel screws provide corrosion resistance for metallic components
- Impact resistant, smooth, thermoplastic elastomer body helps collection point and aids in easy debris removal
- Floating cap rings allows for easy removal of dirt and debris



HBL24W47A



HBL25W47A



Housing Design

- Smooth body design minimizes collection points simplifying the wash down process
- Strain relief nut always seals on the body regardless of cable size, eliminating areas of debris collection



Assembly

- Keyed interior for easy installation
- All stainless steel hardware and corrosion resistant connection points

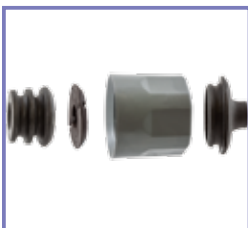

Cord Range

- Hubbell's patented Gotcha® ring and collapsible bushing yields the industry's best strain relief
- Cone seal adjusts to any cable range
- Unique cone seal prevents dirt and debris from collecting at the cable entrance



Contacts

- High conductivity brass termination



Protection

- Triple bypass seal keeps water away from electrical connections and works with previously installed devices
- Free-floating cap allows unwanted material to wash away during sanitation



Plug Blades

- Corrosion resistant connection points

Watertight Receptacles with Lift Covers

Hubbell Watertight receptacles with lift covers provide an impact resistant UL Type 4X seal combined with corrosion resistant metallic components. These universal covers can house any NEMA listed straight blade receptacles as well as any NEMA listed Twist Lock receptacles. The Watertight receptacles can either be mounted to FD/FS boxes (see page C-9) or panel mounted to a flat surface. Combined, this makes a diversified product with the high quality needed in industrial, wet and wash down applications.

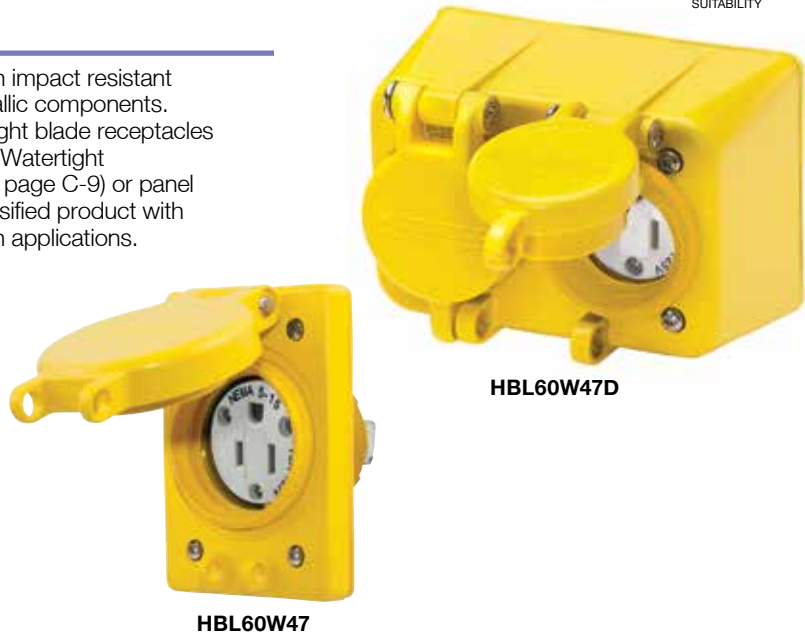

HBL60W47D

HBL60W47



Housing Design

- Impact resistant PBT material lid and cover plate
- Thermoplastic elastomer seal
- Lockable cover meets OSHA Lockout/Tagout regulations



Assembly

- Stainless steel mounting hardware
- Stainless steel hinge spring and pin



HBL14W47A

HBL15W47A



Also Available:

- Watertight Lift Covers, for use with standard receptacles



HBL60W47



HBL60W47D

Straight Blade Devices

	Rating	Plug/Connector	Poles/Wires	Color	Plug	Connector	Receptacle with Lift Cover	Duplex Recept. with Lift Cover
15 Amp	NEMA 5-15 15A 125V		2P/3W	Yellow Black	HBL14W47A HBL14W47BK	HBL15W47A HBL15W47BK	HBL60W47 HBL60W47BK	HBL60W47D —
	NEMA 6-15 15A 250V		2P/3W	Yellow	HBL14W49	HBL15W49	HBL60W49	HBL60W49D
20 Amp	NEMA 5-20 20A 125V		2P/3W	Yellow	HBL14W33A	HBL15W33A	HBL60W33	HBL60W33D
	NEMA 6-20 20A 250V		2P/3W	Yellow	HBL14W48	HBL15W48	HBL60W48	HBL60W48D

Twist-Lock® Devices

	Rating	Plug/ Connector	Poles/ Wires	Color	Plug	Connector	Receptacle with Lift Cover	Duplex Recept. with Lift Cover
15 Amp	NEMA L5-15 15A 125V		2P/3W	Yellow Black	HBL24W47A HBL24W47BK	HBL25W47A HBL25W47BK	HBL65W47 —	HBL65W47D —
	NEMA L6-15 15A 250V		2P/3W	Yellow	HBL24W49	HBL25W49	HBL65W49	HBL65W49D
	NEMA L7-15 15A 277V AC		2P/3W	Yellow Black	HBL24W34 HBL24W34BK	HBL25W34 HBL25W34BK	HBL65W34 —	HBL65W34D —
20 Amp	NEMA L5-20 20A 125V		2P/3W	Yellow Black	HBL26W47 HBL26W47BK	HBL27W47 HBL27W47BK	HBL67W47 —	— —
	NEMA L6-20 20A 250V		2P/3W	Yellow Black	HBL26W48 HBL26W48BK	HBL27W48 HBL27W48BK	HBL67W48 HBL67W48BK	— —
	NEMA L7-20 20A 277V AC		2P/3W	Yellow	HBL26W49	HBL27W49	HBL67W49	—
	NEMA L14-20 20A 125/250V AC		3P/4W	Yellow	HBL26W74	HBL27W74	HBL67W74	—
	NEMA L15-20 20A 3Ø 250V AC		3P/4W	Yellow Black	HBL26W75 HBL26W75BK	HBL27W75 HBL27W75BK	HBL67W75 HBL67W75BK	— —
	NEMA L16-20 20A 3Ø 480V AC		3P/4W	Yellow Black	HBL26W76 HBL26W76BK	HBL27W76 HBL27W76BK	HBL67W76 HBL67W76BK	— —
	NEMA L21-20 20A 3ØY 120/208V AC		4P/5W	Yellow Black	HBL26W81 HBL26W81BK	HBL27W81 HBL27W81BK	HBL67W81 —	— —
	NEMA L22-20 20A 3ØY 277/480V AC		4P/5W	Yellow	HBL26W82	HBL27W82	HBL67W82	—
	NEMA L23-20 20A 3ØY 347/600V		4P/5W	Yellow	HBL26W83	HBL27W83	HBL67W83	—
	20A 125/250V Non-NEMA		3P/3W	Yellow	HBL26W08	HBL27W08	HBL67W08	—
	20A 3ØY 120/208V AC Non-NEMA		4P/4W	Yellow	HBL26W09	HBL27W09	HBL67W09	—
30 Amp	NEMA L5-30 30A 125V		2P/3W	Yellow Black	HBL28W47 HBL28W47BK	HBL29W47 HBL29W47BK	HBL69W47 —	— —
	NEMA L6-30 30A 250V		2P/3W	Yellow Black	HBL28W48 —	HBL29W48 —	HBL69W48 HBL69W48BK	— —
	NEMA L7-30 30A 277V AC		2P/3W	Yellow	HBL28W49	HBL29W49	HBL69W49	—
	NEMA L14-30 30A 125/250V AC		3P/4W	Yellow	HBL28W74	HBL29W74	HBL69W74	—
	NEMA L15-30 30A 3Ø 250V AC		3P/4W	Yellow Black	HBL28W75 HBL28W75BK	HBL29W75 HBL29W75BK	HBL69W75 HBL69W75BK	— —
	NEMA L16-30 30A 3Ø 480V AC		3P/4W	Yellow Black	HBL28W76 HBL28W76BK	HBL29W76 HBL29W76BK	HBL69W76 HBL69W76BK	— —
	NEMA L17-30 30A 3Ø 600V AC		3P/4W	Yellow	HBL28W77	HBL29W77	HBL69W77	—
	NEMA L18-30 30A 3ØY 120/208V AC		4P/4W	Yellow	HBL28W78	HBL29W78	—	—
	NEMA L21-30 30A 3ØY 120/208V AC		4P/5W	Yellow Black	HBL28W81 HBL28W81BK	HBL29W81 HBL29W81BK	HBL69W81 —	— —
	NEMA L22-30 30A 3ØY 277/480V AC		4P/5W	Yellow	HBL28W82	HBL29W82	HBL69W82	—
	NEMA L23-30 30A 3ØY 347/600V AC		4P/5W	Yellow	HBL28W83	HBL29W83	HBL69W83	—
	30A 125/250V Non-NEMA		3P/3W	Yellow	HBL28W08	HBL29W08	HBL69W08	—
	30A 3ØY 120/208V AC Non-NEMA		4P/4W	Yellow	HBL28W09	HBL29W09	—	—





HBL6500



HBL28W75IN



HBL29W75IN



HBLWTB1



HBLWTCS2



HBL50W50

UL Type 4X Watertight Lift Covers

	Description	Color	Lift Cover
Lift Cover Assembly	For use with 15A or 20A straight blade receptacles and 15A Twist-Lock® receptacles; receptacle not included.	Yellow Black	HBL6500 HBL6500BK
	For use with 20A Twist-Lock® receptacles; receptacle not included. <i>Note: When mating with HBL26W09, 20A Non-NEMA plug, use HBL6800 cover.</i>	Yellow Black	HBL6700 HBL6700BK
	For use with 30A Twist-Lock® receptacles; receptacle not included.	Yellow Black	HBL6800 HBL6800BK

Interiors

	Device	125V		3Ø 250V AC		3Ø 480V AC	
		Plug	Receptacle	Plug	Receptacle	Plug	Receptacle
15A	Straight Blade Locking	HBL14W47IN	HBL15W47IN	—	—	—	—
		HBL24W47IN	—	—	—	—	—
20A	Locking	—	HBL27W47IN	HBL26W75IN	—	HBL26W76IN	HBL27W76IN
30A	Locking	—	—	HBL28W75IN	HBL29W75IN	HBL28W76IN	HBL29W76IN

Bushings, Cone Seals and Closure Caps

	Device	Bushings	Cone Seals	Closure Caps	
				Yellow	Black
15A	Straight Blade Locking	HBLWTB1	HBLWTCS1	HBL50W50	HBL50W50BK
		HBLWTB1	HBLWTCS1	HBL50W50	HBL50W50BK
20A	Straight Blade Locking	HBLWTB1	HBLWTCS1	HBL50W50	HBL50W50BK
		HBLWTB2	HBLWTCS2	HBL50W52	HBL50W52BK
30A	Locking	HBLWTB3	HBLWTCS3	HBL50W54	HBL50W54BK

Features and Benefits

UL Type 4X

IP65, 66
SUITABILITY

FD Boxes and Angled Adapters

Hubbell FD boxes and angled adapters are made of high impact resistant material. They are the only NEC compliant box system that has enough wiring room for a 50A Twist Lock device. The stainless steel mounting and grounding bracket provides corrosion resistance, necessary in direct wash down applications. The FD Boxes are UL Type 4X rated when used with Watertight Lift Covers, i.e. HBL6500 or HBL6700 as well as with a blank plate such as HBL60CM88. The box and angled adapter can either be purchase separately or as a kit. The FD box and Adapter can be used with any single or duplex receptacle up to 50A Twist Lock.



HBL60CM55

HBL60CM83A



Housing Design

- 30 cu. in. FD box made of high impact thermoplastic material
- 3/4" NPT and 1" NPT threaded hub options
- Stainless steel mounting/grounding bracket
- External mounting feet, accepts #10 screw



Adapter

- 55° angle adapter (15 cu. in.)
- External mounting feet, accepts #8 screw
- Accepts duplex and single receptacles up to 50A Twist-Lock®

FD Boxes and Angled Adapters

	Description	Catalog Number
Boxes	(2) 3/4" NPT Hubs, FD Box, Yellow	HBL60CM83A
	(2) 3/4" NPT Hubs, FD Box, White	HBL60CM83WA
	(2) 3/4" NPT Hubs, FD Box, Gray	HBL6083
	(2) 1" NPT Hubs, FD Box, Yellow	HBL60CM84A
	(2) 1" NPT Hubs, FD Box, White	HBL60CM84WA
	(2) 1" NPT Hubs, FD Box, Gray	HBL6084
Adapters	55° Angle Adapter, Yellow	HBL60CM55
	55° Angle Adapter, White	HBL60CM55W
	55° Angle Adapter, Gray	HBL6055
Kits	(2) 3/4" NPT Hubs, Box/Adapter Kit, Yellow	HBL60CM83AK
	(2) 3/4" NPT Hubs, Box/Adapter Kit, White	HBL60CM83WAK
	(2) 3/4" NPT Hubs, Box/Adapter Kit, Gray	HBL6083AK
	(2) 1" NPT Hubs, Box/Adapter Kit, Yellow	HBL60CM84AK
	(2) 1" NPT Hubs, Box/Adapter Kit, White	HBL60CM84WAK
	(2) 1" NPT Hubs, Box/Adapter Kit, Gray	HBL6084AK
Covers	Blank Cover Plate, Yellow	HBL60CM88
	Blank Cover Plate, White	HBL60CM88W
	Blank Cover Plate, Gray	HBLP14FS



HBL60CM83A



HBL60CM55



HBL60CM88



HBLP14FS



HBL60CM88W

Features and Benefits

UL Type 4X

GFCI Protected FD Box

The GFCI protected FD box provides a UL Type 4X GFCI enclosure made for wet and damp locations for 30A 120V and 240V Watertight receptacles. The GFCI response time does not exceed .025 seconds ensuring a safe circuit shut down if the current were to deviate from its path. Auto resetting GFCI box, when connected to an FD box by utilizing a PolyTuff® liquid tight conduit provides advanced safety features for Watertight devices.



HBLWTGF120



GFCI Housing Design

- UL enclosure Type 4X, for wet and damp locations. Components are UL and CSA listed
- 30A, 120V and 240V with auto reset
- GFCI response time is .025 sec. Max.
- Grounded neutral protection trips if ground and neutral touch at load side



FD Box

- Utilizes PolyTuff® liquidtight conduit and fittings
- UL enclosure Type 4X, for wet and damp locations. Components are UL and CSA listed
- For use with single and duplex watertight receptacles (single phase only)

Note: Watertight receptacles purchased separately.

GFCI Protected FD Box

	Description	Catalog Number
FD Box	Watertight FD Box, GFCI Module, 30A 120V, Yellow	HBLWTGF120
	Watertight FD Box, GFCI Module, 30A 240V, Yellow	HBLWTGF240



HBLWTGF120
HBLWTGF240

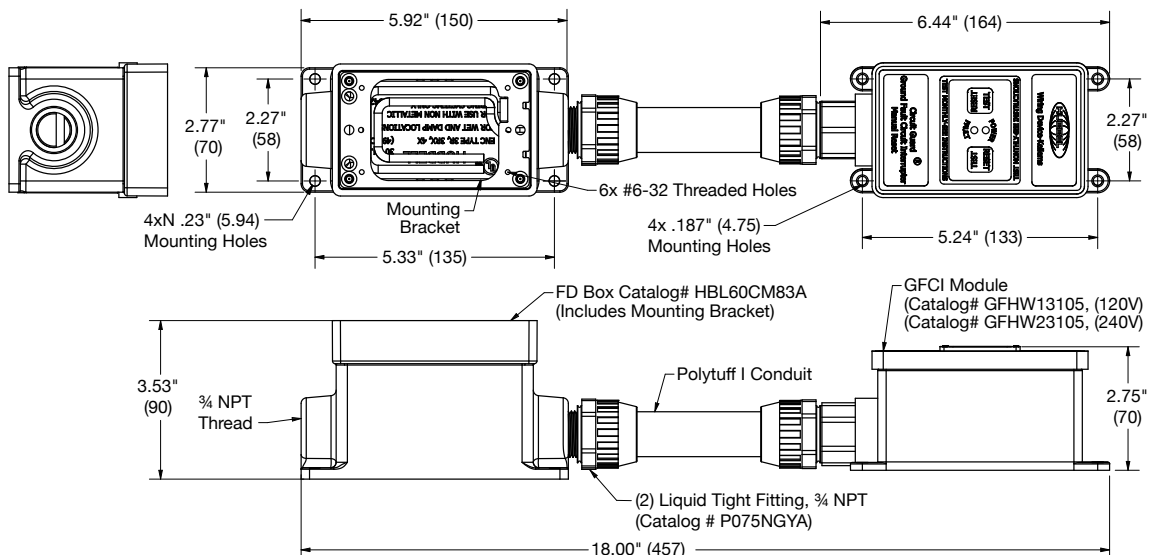

Dimensions in Inches (mm)

Features and Benefits

Box Suitable for Wet and Damp Locations

IP44
SUITABILITY

Portable Outlet Boxes and Covers for Boxes and Panels

The thermoplastic elastomer material of the Portable Outlet Box provides a strong housing with enough capacity for multiple devices to fit, with cord feed through options available. The impact resistant PBT covers add to the durability of the box and the devices inside. There are several cord connectors available ranging from standard to deluxe, providing unmatched strain relief. The covers provide a UL Type 3R weather resistant seal suitable for wet and damp locations. Portable Outlet Boxes are available as pre-assembled or can be configured as needed.



Housing Design

- Fully thermoplastic elastomer housing exceeds UL crush requirements
- Wiring room large enough to accommodate the broadest range of device requirements in one size box
- Extended wall protects lift covers from impact damage
- Brass inserts for maximum strength



Covers

- Impact resistant PBT material
- UL Type 3R seal on a panel or on a portable outlet box
- Stainless steel hinge and spring

Pre-Assembled Portable Outlet Boxes (with Cord Connector Installed)

	Description	Cord Range Inches (mm)	Catalog Number
Boxes	Portable Outlet Box, Deep, Yellow	.38"-.50" (9.7-12.7)	HBL3099
	Portable Outlet Box, Deep, Feed Thru, Yellow	.38"-.50" (9.7-12.7)	HBL3090F
	Portable Outlet Box, Deep, Yellow with (2) duplex plates	.38"-.50" (9.7-12.7)	HBL3000



Configurable Portable Outlet Boxes

	Empty Box Options	Catalog Number	Cord Range Inches (mm)	Cord Connector Options		Deluxe Cord Connectors
				Gray Nylon	Black Nylon	
Boxes	Outlet Box, Yellow	HBL3080	.38"-.50" (9.7-12.7)	SHC1039CR	—	—
	Outlet Box, Black	HBL3080BK	.50"-.63" (12.7-15.9)	SHC1040CR	SHC2040CR	CG810NM
	Feed Thru Box, Yellow	HBL3080F	.63"-.75" (15.9-19.0)	SHC1041CR	SHC2041CR	074011341
	Feed Thru Box, Black	HBL3080FBK	.75"-.88" (19.0-22.2)	SHC1042CR	SHC2042CR	074011342
			.88"-.1.00" (22.2-25.4)	SHC1043CR	SHC2043CR	074011343
			.59"-.1.00" (15.0-25.4)	SEC100GA	SEC100BA	—



Covers for Portable Outlet Boxes and Panels

	Description	UL Type 3R	UL Type 1
Box Covers	Outlet box cover, duplex receptacle	HBL3056	HBL3051
	Outlet box cover, 1.39" diameter receptacle	HBL3057	HBL3052
	Outlet box cover, 1.572" diameter receptacle	HBL3058	HBL3055
	Outlet box cover; GFCI	HBL3061	HBL3060
	Outlet box coverplate, blank	HBL3054	—





HBLPOB1



Cover Plates



**Deluxe Cord Grips
(purchased separately)**



**Gray Nylon
Cord Connector**

Heavy Duty Portable Outlet Boxes and Cover Plates

Description	Catalog Number
Box with cord strain relief, with one blank cover plate.	HBLPOB1
Box with cord strain relief, with one blank cover plate, black.	HBLPOB1BK
Box with cord strain relief, with two duplex (indoor) cover plates.	HBLPOB1D
Box with cord strain relief, with two duplex (indoor), yellow cover plates.	HBLPOB1DY
Blank, non-metallic FS cover plate with foam gasket, gray.	HBLP14FS
Duplex, non-metallic FS cover plate, gray.	HBLP8FS
Duplex, non-metallic FS cover plate, yellow.	HBLP8FSY
Single receptacle (1.39"), non-metallic FS cover plate, gray.	HBLP7FS
Single receptacle (1.56"), non-metallic FS cover plate, gray.	HBLP720FS
Rectangular opening, non-metallic FS cover plate, gray.	HBLP26FS

Other Cover Plates and Devices which may be used with Heavy Duty Portable Outlet Boxes

Description	Catalog Number
Duplex cover plate, weatherproof.	HBL5221, HBL52CM21
Single receptacle (1.39") cover plate, weatherproof.	HBL7423WO, HBL74CM23WO
Single receptacle (1.56") cover plate, weatherproof.	HBL7425WOA, HBL74CM25WOA
Safety-Shroud Twist-Lock® surface receptacles.	HBL2310SR, HBL2320SR, HBL2330SR, HBL2610SR, HBL2620SR

Note: Standard product gray, CM yellow.

Deluxe Cord Grips Straight Male Thread Nylon Fittings, Stainless Steel Mesh, Liquidtight, for Insulated Cables

Grip Diameter Range Inches (cm.)	Thread Size NPT (inches)	Form Size	Catalog Number
.375"-.500" (.97-1.27)	¾"	F3	074011335
.500"-.625" (1.27-1.59)	¾"	F3	074011336
.625"-.750" (1.59-1.90)	¾"	F3	074011337

Nylon Cord Connector Straight Male Thread

Grip Diameter Range Inches (cm.)	Thread Size NPT (inches)	Form Size	Catalog Number
.375"-.500" (.97-1.27)	¾"	F3	SHC1035CR
.500"-.625" (1.27-1.59)	¾"	F3	SHC1036CR
.625"-.750" (1.59-1.90)	¾"	F3	SHC1037CR

Specifications for Heavy Duty Portable Outlet Boxes and Cover Plates

UL Listed	UL 514C, UL467 and UL50 Enclosures Types 1, 3R.
CSA Certified	C22.2 No. 18 and C22.2 No. 94 Enclosures Types 1, 3R and C22.2 No. 0.4 (Impedance).
Box Specifications:	
Moisture Resistance	Wet and damp locations, Enclosure Type 3R when used with weatherproof cover plates. Dry, indoors locations, Enclosure Type 1 with all other cover plates.
Flammability	UL 94V-0, 94-5VA classification.
Operating Temperature	80°C maximum; -35°C minimum.
UV Resistance	All materials are UV stabilized.
Impact and Crush Resistance	in accordance with UL 514C, UL50, C22.2 No. 18 and C22.2 No. 94.
Material	Valox®.
Cord Connector Materials	Nylon nut; Nylon Gotcha® ring; Neoprene grommet.
Cord Diameter Range	.38" to .75" diameter.
Bonding Strap Material	Brass.
Threaded Inserts	Brass.
Grounding Screw Material	Brass.
Indoor Cover Plate Screws Material	Zinc Plated Steel.
Outdoor Cover Plate Screws Material	Stainless Steel.
Cover Plate Gasket Material	UL recognized closed-cell foam (aging and oil resistant).

Dimensions

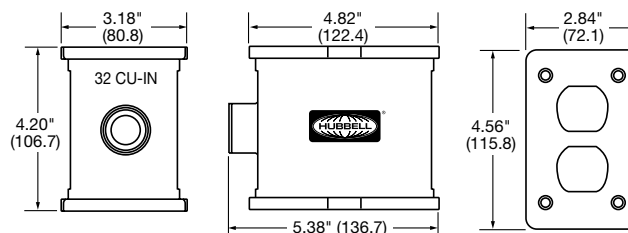

HBLPOB1

Dimensions in Inches (mm)

Valox® is a trademark of SABIC Innovative Plastics, acquired from General Electric Company.

Watertight Devices

Plugs and Connectors Inches (mm)

		15A & 20A Straight Blade	15A Non-NEMA Straight Blade	15A Twist-Lock®	20A Twist-Lock®	30A Twist-Lock®
Plugs	A	1.85" (47.07)	1.63" (41.40)	1.85" (47.07)	2.51" (63.70)	2.77" (70.41)
	B	3.16" (80.27)	2.68" (68.00)	3.21" (81.46)	3.96" (100.69)	3.94" (99.98)
Connectors	C	1.85" (47.07)	1.80" (46.00)	1.85" (47.07)	2.51" (63.70)	2.77" (70.41)
	D	4.42" (112.14)	4.00" (102.00)	4.62" (117.22)	5.69" (144.55)	5.67" (144.00)

Note: For HBL26W09 and HBL27W09 use 30A Twist-Lock® dimensions.

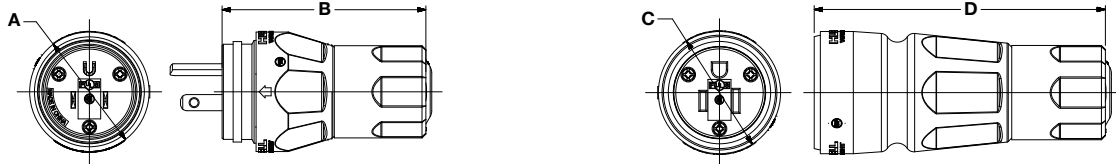

Receptacles with Lift Covers Inches (mm)

	15A & 20A Straight Blade	15A Twist-Lock®	20A Twist-Lock®	20A Non-NEMA	30A Twist-Lock®	30A Non-NEMA
A	4.56" (115.9)	4.56" (115.9)	4.56" (115.9)	4.56" (115.9)	4.56" (115.9)	4.56" (115.9)
B	3.10" (78.7)	3.10" (78.7)	3.10" (78.7)	3.10" (78.7)	3.10" (78.7)	3.10" (78.7)
C	1.20" (30.6)	1.20" (30.6)	1.20" (30.6)	1.20" (30.6)	1.20" (30.6)	1.20" (30.6)
D	3.25" (82.6)	3.25" (82.6)	3.25" (82.6)	3.25" (82.6)	3.25" (82.6)	3.25" (82.6)
E	1.88" (47.6)	1.88" (47.6)	1.88" (47.6)	1.88" (47.6)	1.88" (47.6)	1.88" (47.6)
F	1.26" (32.0)	1.46" (37.1)	1.72" (43.7)	2.26" (57.4)	1.72" (43.7)	1.97" (50.0)
G	1.63" (41.4)	1.63" (41.4)	2.25" (57.2)	2.25" (57.2)	2.25" (57.2)	2.25" (57.2)
H	5.00" (127.0)	5.00" (127.0)	5.00" (127.0)	5.00" (127.0)	5.00" (127.0)	5.00" (127.0)

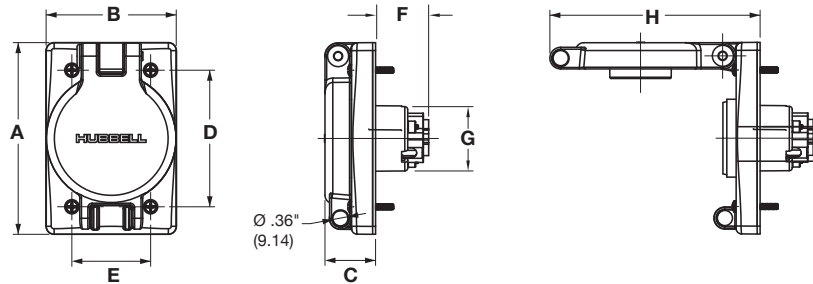

Portable Outlet Boxes Inches (mm)

	Pre-Assembled	Configurable
A	4.30" (109.2)	4.30" (109.2)
B	5.00" (127.0)	5.00" (127.0)
C	2.77" (70.4)	2.77" (70.4)
D	3.28" (83.3)	3.28" (83.3)
E	5.79" (147.0)	—
F	7.28" (184.9)	—

Box Covers Inches (mm)

	Covers
A	3.78" (96.0)
B	2.28" (57.9)
C	0.27" (6.9)
D	3.28" (83.3)
E	1.87" (47.5)
F	3.25" (82.6)

Note: Style shown is representative of all openings.

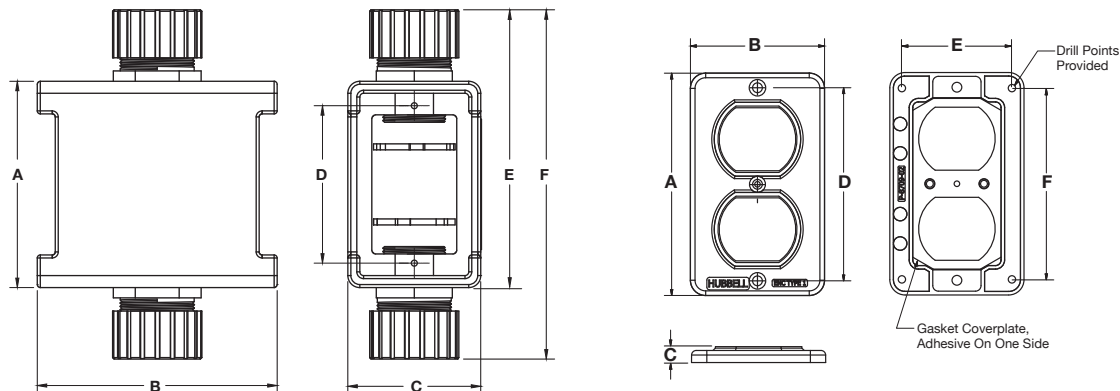

Dimensions in Inches (mm)

Watertight Devices

Materials

Plug/Connector

Part	Materials
Blade/Contact Carrier	Nylon, white
Terminal Retainer	Polycarbonate, clear
Housing	Thermoplastic elastomer
Housing Insert	Nylon, white
Strain Relief Nut	PBT thermoplastic, gray
Blades/Contacts	Brass, nickel plated
Terminal Screws	Brass
Terminal Screw Size	#8-32 15A/20A Straight Blade and 15A Twist-Lock; #10-32 20A and 30A Twist-Lock
Assembly Screws	Stainless Steel
Bushings	Thermoplastic elastomer, black
Gotcha Ring	Nylon
Cone Seal	Thermoplastic elastomer, black
Closure Cap	Thermoplastic elastomer

Receptacle Assembly

Part	Materials
Base, Flip Lid and Backplate	PBT
Seal Collar	Thermoplastic elastomer
Mounting Screws	Stainless Steel
Spring and Hinge Pin	Stainless Steel

Portable Outlet Box and Accessories

Part	Materials
Box Enclosure	Thermoplastic elastomer
Strain Relief Nut	PBT
Grommet	Thermoplastic elastomer
Gotcha Ring	Nylon
Locknut	Steel, zinc plate
Threaded Inserts	Brass
Receptacle Screw	Stainless steel
Cover Plate	PBT
Cover Plate Seal	Neoprene
Cover Plate Spring	Stainless steel
Hinge Pin	Stainless steel
Hinge Bracket	Zinc plated steel
Rivets	Zinc plated steel

Specifications

Listings (Plug/Connector and Flip Lid Assembly)

Listed to UL498
 Certified to CSA C22.2 No. 42
 Meets NEMA WD-1, WD-6, and ANSI standards
 IP66 Suitability
 NSF Certified (Plugs, Connectors and Receptacles)

FD Box/Adapter

Part	Materials
Box Enclosure	PBT
Ground Bracket	316 Stainless Steel
Ground Screw	Brass
Angle Adapter	PBT

Environmental

Box	UL Type 4X (with UL Type 4X receptacle assembly) UL Type 3R (with weatherproof cover plate)
-----	--

Performance

Electrical

Dielectric Voltage	
Connectors:	2000V AC if rated 300V or less; 3000V AC if rated above 300V
Plugs:	2500V AC if rated 300V or less; 3500V AC if rated above 300V
Max Working Voltage	As marked
Current Interrupting	Rated for current interruption per UL498
Temperature Rise	30°C max per UL498 at rated current

Mechanical

Cord and terminal accommodations:

Plugs and Connectors

15 and 20A Straight Blade and 15A Locking	16/3 SJ to 10/3 SJ, 18/3 S to 12/3 S, (Ø.325" to Ø625") (Ø8.3mm to Ø15.9 mm)
20A Locking Except HBL26W09 & HBL27W09	Min. Cord: 16/3 SJ, 18/3 S, 18/4 SJ, 18/4 S, 18/5 S, (Ø.325") (Ø8.3 mm) Max. Cord: 10/3 S, 10/4 S, 10/5 S (.875") (22.2 mm)
30A Locking Including HBL26W09 & HBL27W09	Min Cords: 12/3 SJ, 16/3 S, 14/4 SJ, 18/4 S, 18/5 S, (Ø.375") (Ø9.5 mm) Max Cord: 8/3 S, 8/4 S, 10/5 S (1.125") (28.6 mm)

Receptacles – use solid or stranded building wire or flexible cord only as outlined below:

All Straight Blade	18 AWG to 10 AWG
15A Locking	18 AWG to 10 AWG
20A and 30A Locking	18 AWG to 8 AWG

Portable Outlet Boxes

Cord Range	.38" to .68" (HBL3099, HBL3090F, HBL3000) and .38" to 1.00" with user-specified cord connector
Wiring Volume	19.0 in ³

Environmental

Moisture Resistance	UL Listed to 3R, 3RX, 4, 4X, 6, 6P, 12 (Plugs and connectors); 3R, 3RX, 4, 4X (Receptacles); Wet and Damp Locations (Portable outlet boxes); Covers (POB) UL Type 3R and Wet Locations cover closed
Flammability	UL94V0 (boxes, covers, and plates); UL94V2 (Plugs, connectors, and interiors); UL94HB (Caps, bushings, and cone seals) -40°C (without impact) to +60°C continuous
Operating Temperatures	All exposed materials are UV stabilized
UV Resistance	